

ARCHIVES
of
FOUNDRY ENGINEERING

DOI: 10.2478/afe-2013-0013

Published quarterly as the organ of the Foundry Commission of the Polish Academy of Sciences



ISSN (2299-2944)
Volume 13
Issue 1/2013

69 – 72

Investigations of the Influence of the Matrix Recycling on Properties of the Moulding Sand with Geopol 618 Binder

J. Kamińska

AGH University of Science and Technology, Faculty of Foundry Engineering, Department of Foundry Processes Engineering, ul. Reymonta 23, 30-059 Crakow, Poland
Corresponding author. E-mail address: kaminska@agh.edu.pl

Received 09.07.2012; accepted in revised form 04.09.2012

Abstract

Self-hardening moulding sands with water-glass hardened by liquid esters are applied in several foundry plants for making moulds for the production of heavy iron and steel castings. The main good point of this process is a low cost of sands. However, on account of a low susceptibility of this moulding sand for the matrix reclamation the fraction of sands originated from the reclamation is limited. The investigations presented in this work were aimed at the determination of the addition of the reclaimed material, obtained in the dry mechanical reclamation, on properties of the moulding sand with the Geopol 618 binder, which is water-glass modified by polymers and hardened by esters.

Keywords: Self-hardening moulding sands, Reclamation, Environment protection

1. Introduction

Striving after decreasing raw materials wearing and their maximum utilisation is a constant feature of the foundry industry. One of the methods allowing to make the foundry industry more ecological and economical is the reclamation of spent moulding sands.

Constantly growing requirements concerning the environment protection technologies, which assure the lowest hazard for the environment at retaining the required technological parameters, are becoming more and more important. Among the moulding sands these requirements are met by the moulding sand with water-glass. However, taking into account inorganic character of this binder, these sands are characterised by a low reclaimability and bad knocking out ability [1-7].

Effects of the reclamations of spent moulding and core sands,

which the foundry practice considers as especially difficult for this process, is based on several instrumental investigations allowing to assess the technological usefulness of the reclaimed matrix in the given device. When mechanical reclaimers of various mechanisms of influencing moulding sands are applied it is difficult to perform the comparable assessment of the reclamation of various sands, in case when the applied system leading to releasing matrix grains from coatings of binding material is changed [8, 9].

Apart from the spent sand with water-glass (floster process) and CO₂ also moulding sands with alkaline phenolic resins (alpha-set process) belong to difficult for the reclamation sands as well as moulding sands with strongly alkaline resins, bond by means of CO₂ [10, 11].

2. Experimental stand

The reclamation process was performed by means of the test apparatus, for the assessment of the reclaiming ability of spent sands, in which impact-abrasive rotating elements were applied. Rotational speed of these elements was 560 rpm and the reclamation time was 10 minutes. The reclaiming ability was tested on spent moulding sand with the binder: Geopol 618 (water-glass modified by polymers) and the activator: SA 63.

The spent sand was heated at a temperature of 300°C for 8 hours, before the reclamation process. The mass loss of the binder sample was 0.94 % at 300°C and 1.13 % at 850°C.

The pictorial diagram of the testing equipment [12-15], applied in investigation is presented in Figure 1.

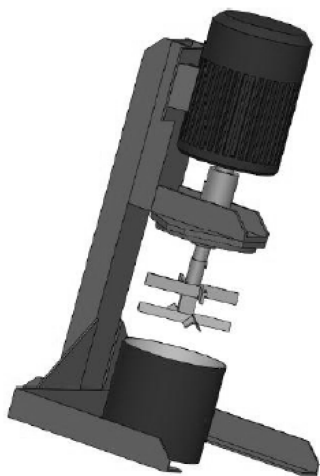

Fig. 1. Pictorial diagram of the test apparatus: AT-2 [12-15]

3. Program of the research

The obtained results of the influence of additions of the reclaimed material, obtained in successive reclamation cycles of spent sand with water-glass, on the moulding sand strength properties, are presented in the paper.

Moulding sand for the investigations was prepared in the laboratory ribbon mixer. This preparation was carried out according to the recommendations of the resin producer. The composition of the moulding sand prepared from fresh sand was as follows (Cycle 1):

- dry high-silica sand 100 parts by weigh,
- binder (Geopol 618) 2.3 parts by weight,
- hardener (SA 63) 0.35 parts by weight.

In successive cycles (Cycles 2-4) the high-silica sand (50 %) and the reclaimed material obtained in the previous cycle (50 %) were used as the matrix. Amounts of resin and activator were without changes.

After the preparation the moulding sand was hardened for 24 hours and then underwent the primary and secondary reclamation. Schematic presentation of investigations is given in Figure 2.

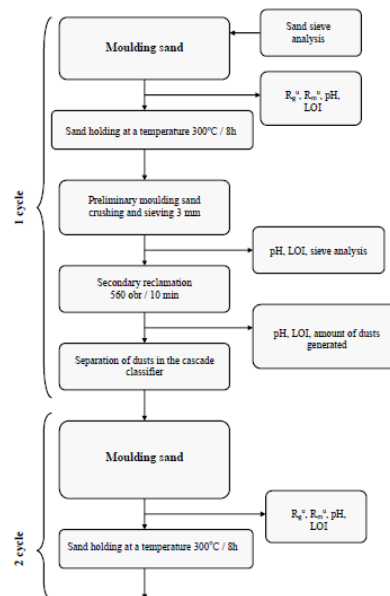

Fig. 2. Schematic presentation of the performed investigations

4. The obtained results

A sieve analysis was performed for the fresh high-silica sand as well as for the moulding sand after the preliminary crushing and sieving and after the mechanical reclamation.

Changes of the average grain diameter d_L of the fresh sand, of the sand after the preliminary crushing and of the spent sand after the reclamation treatment in the AT-2 tester, are presented in Figure 3. Comparing data from Figure 3 one can notice the increasing d_L value as the number of the reclamation cycles increases. For the sand on the matrix of sand and the reclaimed material from Cycle 1 the average grain size after crushing and after the reclamation is the same. In the case of successive cycles the d_L value after the secondary reclamation process is lower than after the primary reclamation, which indicates that grain diameters are decreasing when grains are relieved from coatings of binding materials.

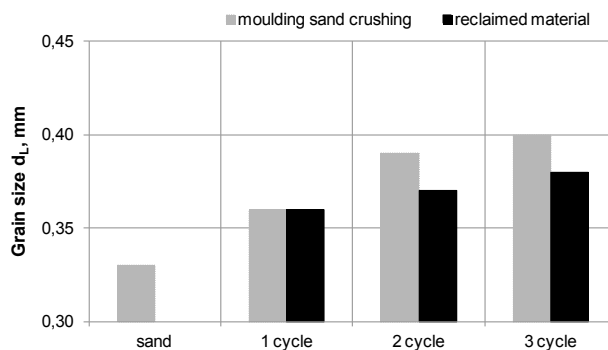

Fig. 3. Average grain size d_L in dependence on the reclamation cycles number

The influence of the reclamation cycles number on the theoretical specific surface, S_t , of the sand after the crushing and mechanical reclamation in the test apparatus is presented in the diagram (Fig. 4). It can be seen that the higher number of the reclamation cycles the smaller theoretical surface area. The decrease of the theoretical specific surface results from the fact that the average diameter of the grain set decreases due to a complete removal, from their surface, of spent binding materials.

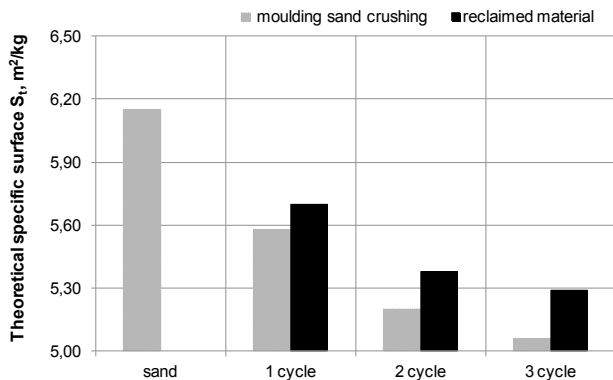

Fig. 4. Theoretical specific surface S_t in dependence on the reclamation cycles number

After each investigation stage ignition losses were checked (850°C/2h). The determination of the ignition loss was done for moulding sands samples after the crushing process and after the final reclamation, which means after removal of dusty phase from the reclaimed material. The obtained results are presented in Figure 5.

The ignition loss value informs on the amount of organic binder, being the modifying component of water-glass, which remained on the matrix after the reclamation process. The analysis of Figure 5 indicates that ignition losses of reclaims after the mechanical reclamation process decrease with the increase of the reclamation cycles number. Regardless of the decreasing of ignition losses of the reclaim after successive reclamation cycles the total value of these losses in the matrix increases.

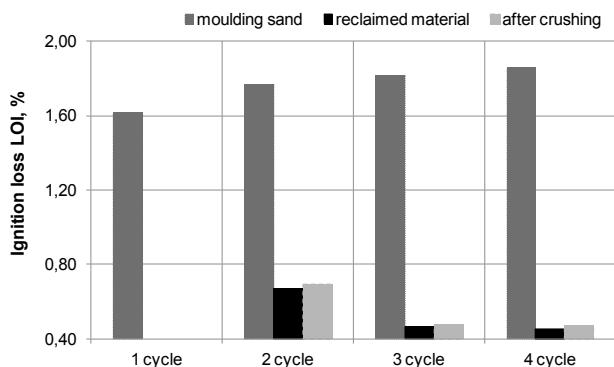

Fig. 5. Dependence of the ignition loss on the reclamation cycles number

The change of the pH value of the tested samples is presented in Figure 6. It is seen that the pH value shifts in the direction of alkalinity after the crushing process and the secondary reclamation in dependence on the reclamation cycles number. The pH value for all investigated samples increases with the number of the reclamation cycles, which indicates the binder accumulation in the matrix.

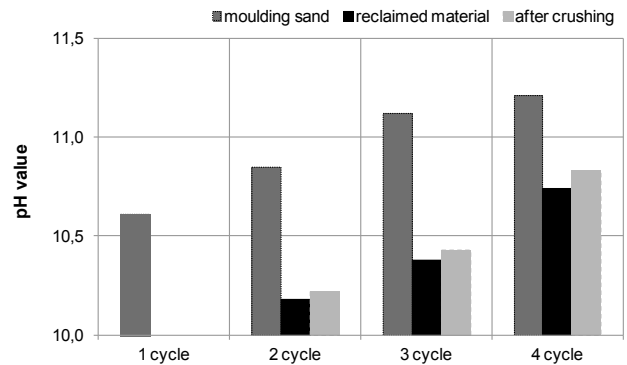

Fig. 6. Dependence of the pH value on the reclamation cycles number

The dependence of the tensile strength on the number of the reclamation cycles performed in the testing apparatus is presented in Figure 7. It can be noticed that, within the whole range of the hardening time, the highest strength achieves the moulding sand on the matrix of the fresh high-silica sand and reclaim from Cycle 3. The highest strength this sand obtains after 2 hours of hardening, $R_m^u = 0.82$ MPa.

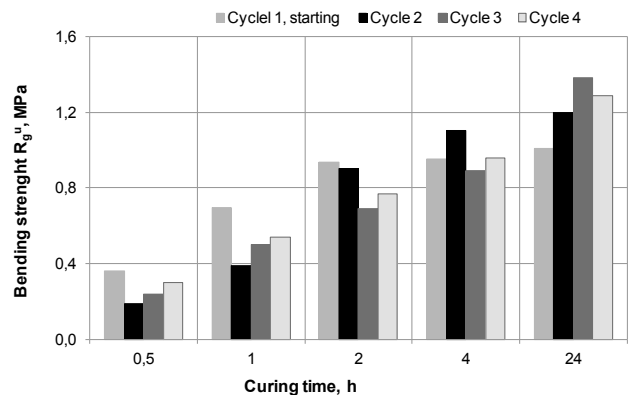

Fig. 7. Dependence of the tensile strength R_m^u on the reclamation cycles number

The dependence of the bending strength of samples on the number of the reclamation cycles is shown in Figure 8. At the beginning of the hardening time (0.5 - 2 h) the highest strength characterises the sand on the fresh high-silica sand. After 24 hours of hardening the highest strength achieved the moulding sand on the matrix of fresh sand and the reclaim from Cycle 2.

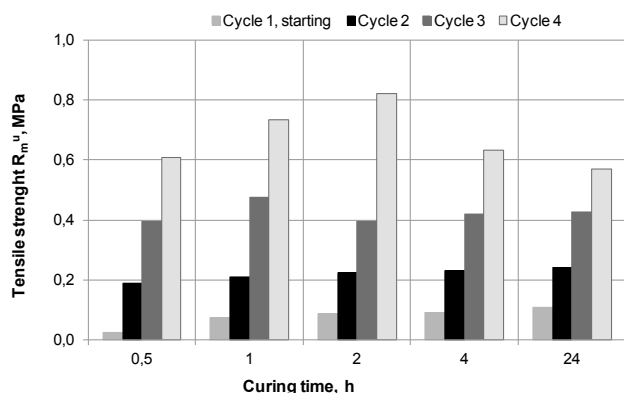

Fig. 8. Dependence of the bending strength R_g^u on the reclamation cycles number

4. Conclusions

On the grounds of the performed investigations several conclusions can be drawn:

- Increasing number of the reclamation cycles causes a decrease of the theoretical surface, S_t , at a simultaneous increase of the average grain diameters, d_t , of the investigated set.
- Ignition loss values of the reclaimed material decrease with the reclamation cycles number increase, at a simultaneous increase of the total ignition loss value in the sand containing the reclaimed material.
- The mass loss of the binder sample was 0.94 % at a temperature of 300°C and 1.13 % at 850°C.
- With the increase of the number of the reclamation cycles the alkalinity of samples increases.
- Within the whole range of the hardening time the highest tensile strength R_m^u achieves moulding sand on the matrix of the fresh high-silica sand with the reclaim from Cycle 3, which after 4 hours of hardening obtains $R_m^u = 0.82$ MPa.
- At the beginning of the hardening time (0.5 – 2 h) the highest bending strength R_g^u characterises the sand on the matrix of the fresh high-silica sand. After 24 hours of hardening the highest strength achieved the moulding sand on the matrix of the fresh sand and the reclaim from Cycle 2.
- Investigation allow to state that the sand pH value is successively increasing in subsequent cycles of its treatment. The limit - at which these effects stabilize - was not reached within the scope of these investigations.

Acknowledgements

The study was performed within the ‘Dean’s Grant’ 2012 No.15.11.170.417.

References

- [1] Dańko, R. (2010). Badania zdolności do regeneracji masy zużytej ze szkłem wodnym oraz z alkaliczną żywicą utwardzaną CO_2 . *Archives of Foundry Engineering*. 10(2), 33-38.
- [2] Integrated Pollution and Control (2005). *Reference Document on Best Available Techniques in the Smitheries and Foundries Industry*. European Commission.
- [3] Izdebska-Szanda, I., Pezarski, F. & Stępniewski, K. (2008). Application of design Project developer by Foundry Research Institute in Krakow in construction of integrated stand for processing and reclamation of moulding sands. *Archives of Foundry Engineering*. 8(1), 133-138.
- [4] Pribulová, A., Barošová, A. & Greguš, M. (2011). Regenerácia furanových formovacích zmesí. *Acta Metallurgica Slovaca*. 238-243.
- [5] Dańko, R. (2011). Innovative developments in sand reclamation technologies. *Metalurgija – Metallurgy*. 50(2), 93-96.
- [6] Dańko, R. & Holtzer M. (2010). Moulding sands grain size investigations by means of the laser method of measurement. *Archives of Metallurgy and Material.s* 55(3), 787-794.
- [7] Dańko, R., Holtzer, M. & Dańko, J. (2011). Reclamation of alkaline spent moulding sands of organic and inorganic type and their mixtures. *Archives of Foundry Engineering*. 11(4), 25-30.
- [8] Dańko, R. (2009). Analysis of effectiveness of used sands reclamation treatment – in various technological devices. *Archives of Foundry Engineering*. 9(4), 31-36.
- [9] Dańko, R. (2010). Experiences gathered during reclamation of used water glass and bentonite sands in extra low and ambient temperature. *International Journal of Cast Metals Research*. 23(2), 92-96. DOI: 10.1179/174313309X451270
- [10] Dańko, J., Dańko, R. & Łucarz, M. (2007). *Procesy i urządzenia do regeneracji osnowy zużytych mas formierskich*. Kraków, Wydawnictwo Naukowe AKAPIT.
- [11] Dańko, J. & Dańko, R. (2011). Reclaimability of the spent sand mixture – sand with bentonite – sand with furfuryl resin. *Archives of Foundry Engineering*. 11(2), 13-18.
- [12] Dańko, J., Holtzer, M., Dańko, R. & Grabowska, B. (2008). Analiza i struktura odpadów z krajowych odlewni. *Archives of Foundry Engineering*. 8(2), 5-9.
- [13] Dańko, R. & Kamińska, J. (2009). Procesy regeneracji zużytych mas formierskich i rdzeniowych. *Sesje Studenckich Kół Naukowych*. 2, Kraków, 253.
- [14] Dańko, R. & Kamińska, J. (2009). Assessment of reclamation of used sands from the alpha-set technology in the testing apparatus. *Archives of Foundry Engineering*. 9(1), 33-37.
- [15] Major-Gabryś, K., Dobosz, St. M., Dańko, R. & Jakubski, J. (2011). The estimation of ability to reclame of moduling sands with biopolymer binders. *Archives of Foundry Engineering*. 11(2), 79-84.